

Das kannst du!

Name: _____

Löse die Rechenmauern! Kontrolliere mit Hilfe der Zielzahlen!

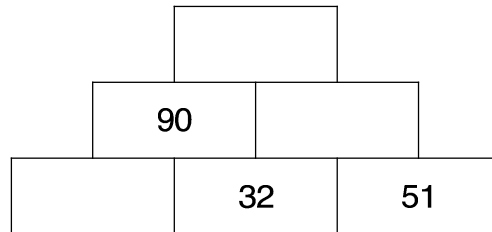
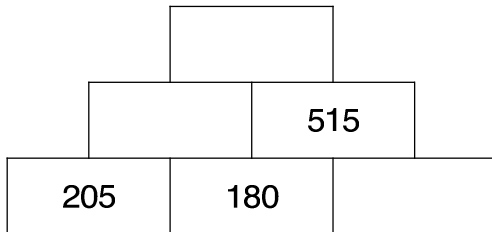

Zielzahlen:
173
800
900

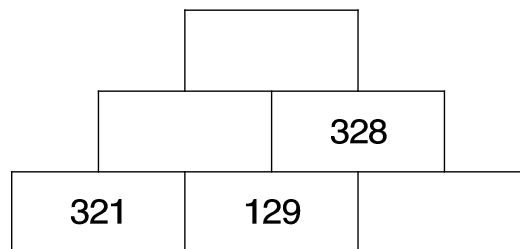
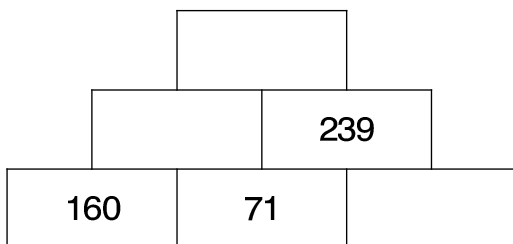

Zielzahlen:
470
777
778

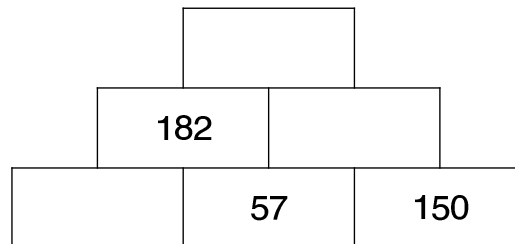
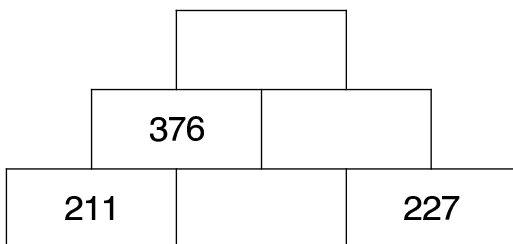

Zielzahlen:
399
768
389

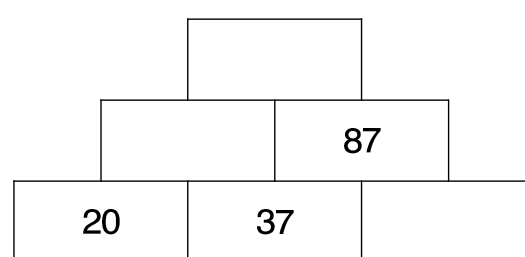
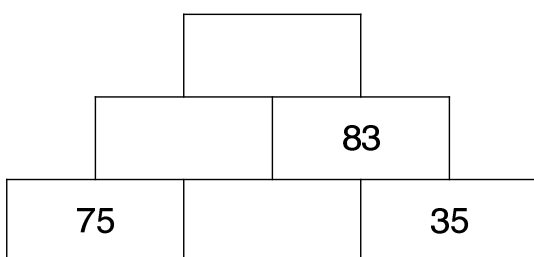

Zielzahlen:
144
602
206

Das schaffst du auch!

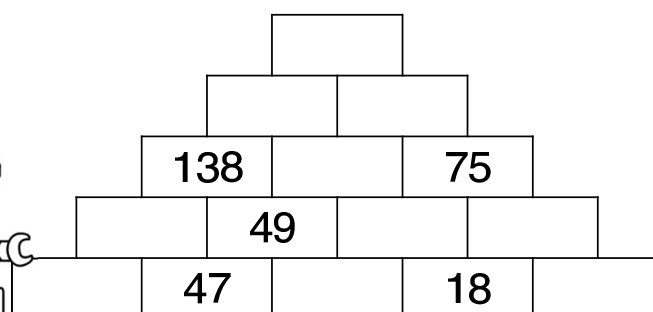
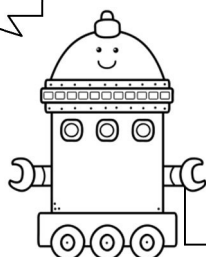

Zielzahlen: 135 351 531

Das kannst du!

Name:

Ergänze die fehlenden Zahlen in den Rechenrädern!

Kontrolliere!

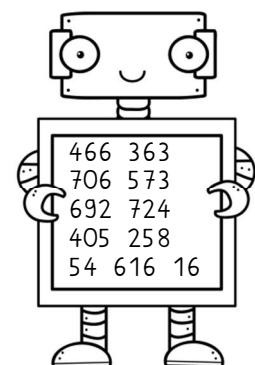
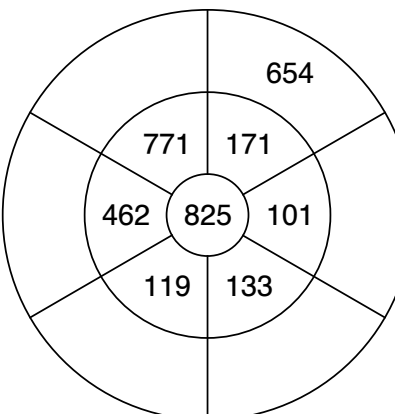
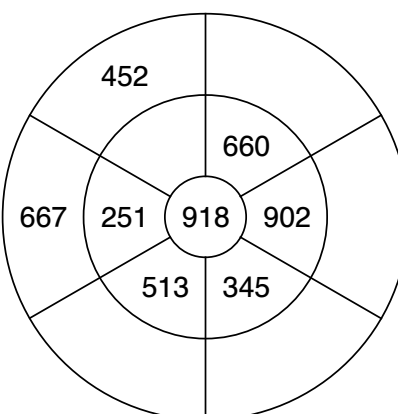
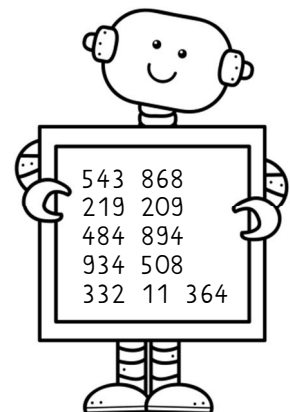
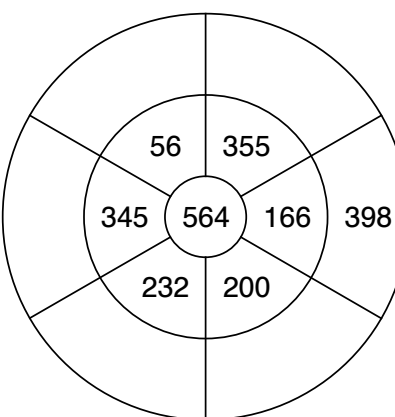
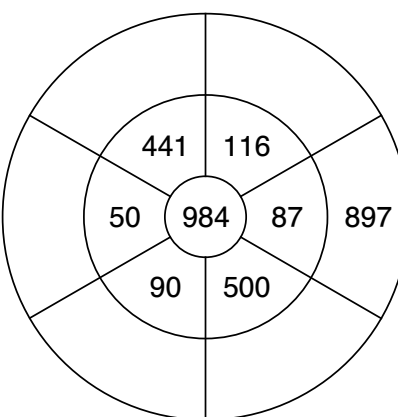
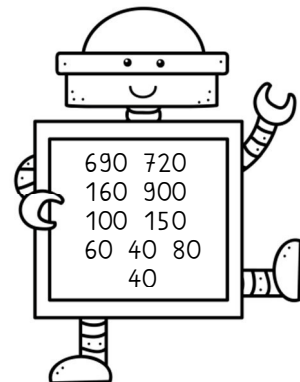
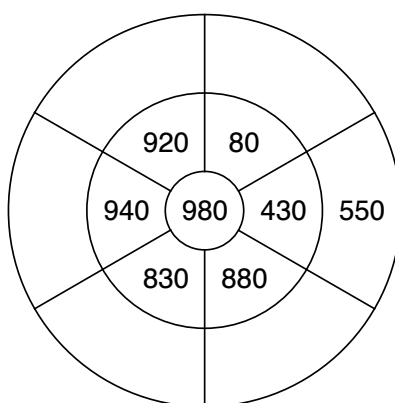
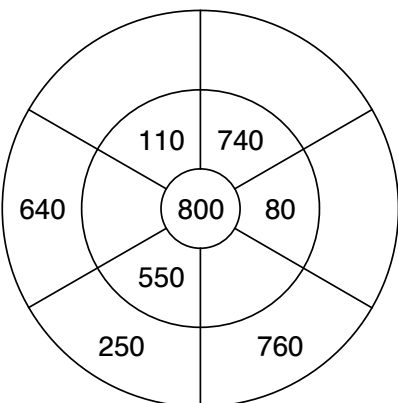
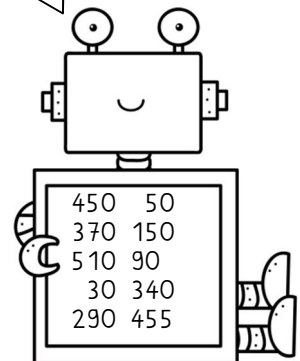
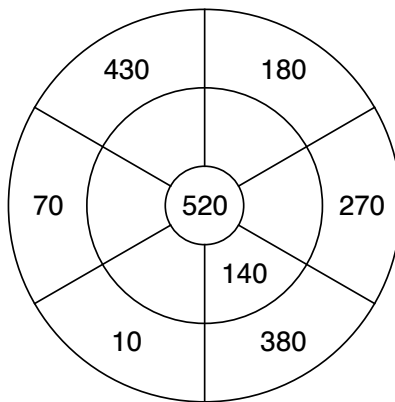
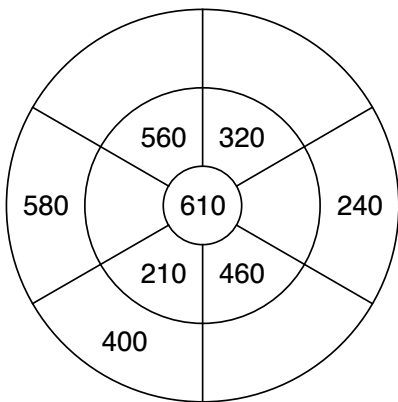

Das kannst du!

Name:

Tausenderfreude! Ergänze immer auf 1000!

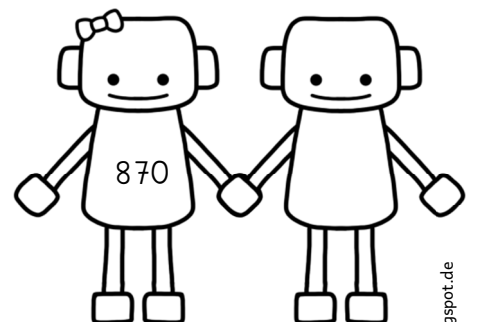
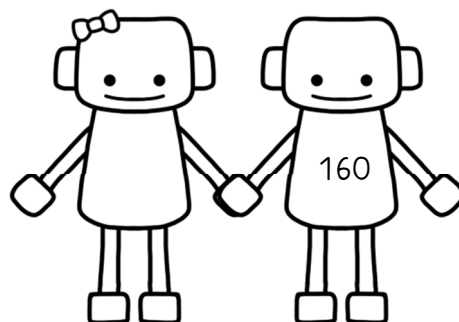
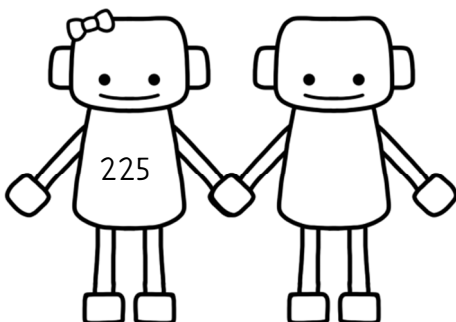
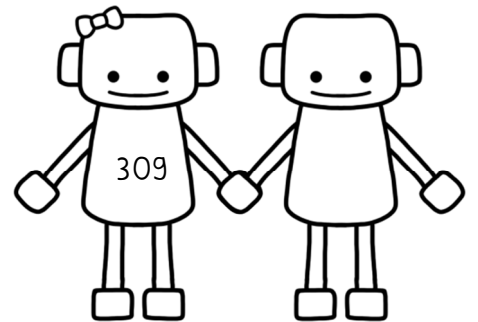
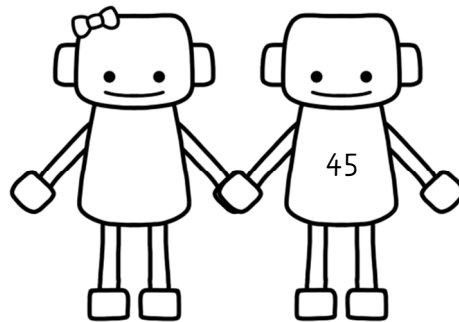
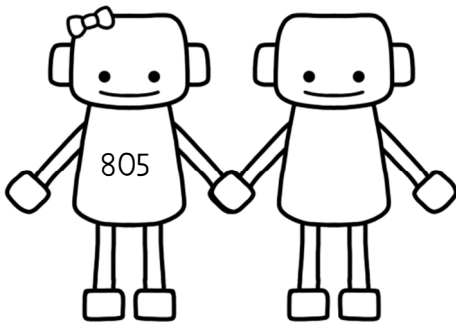
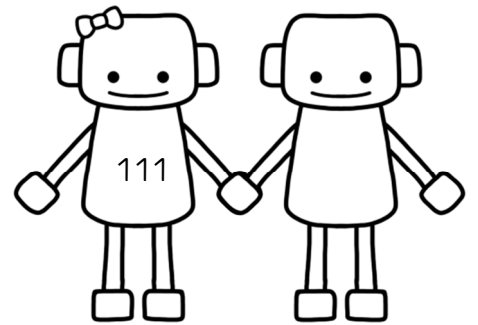
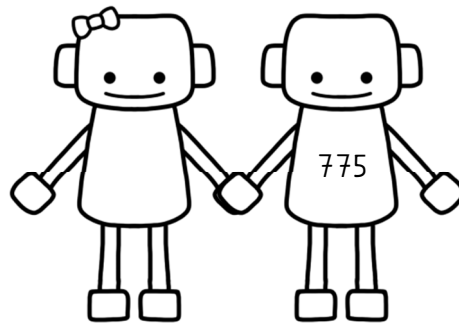
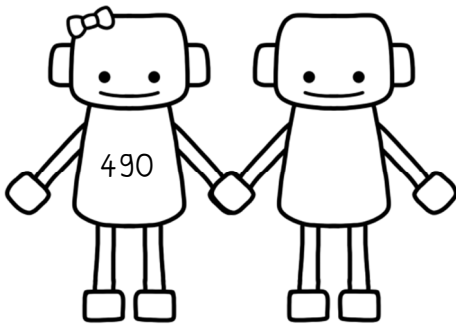
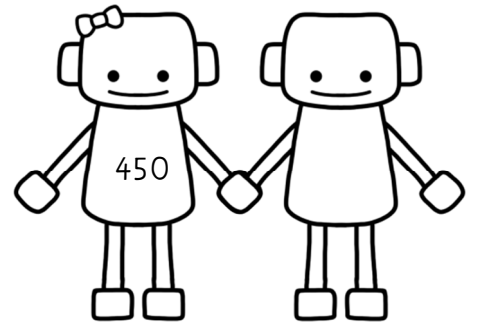
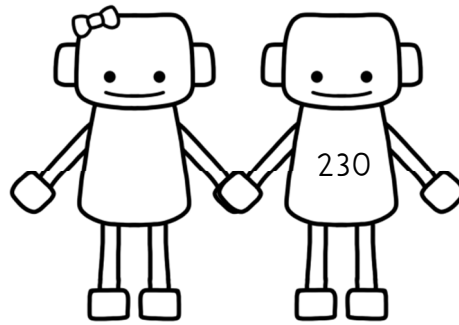
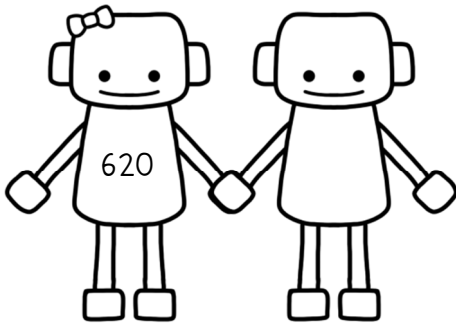

Lösungen: 691 195 775 380 550 230 840 225 510 955 889 770 130

Das kannst du!

Name: _____

Bilde aus den beiden Zahlen eine sinnvolle Subtraktionsaufgabe. Löse sie, indem du schriftlich rechnest. Kontrolliere!

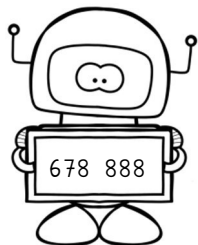

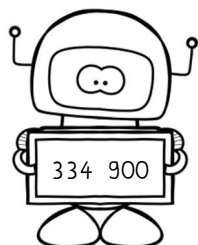

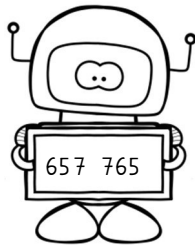

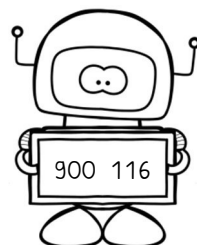

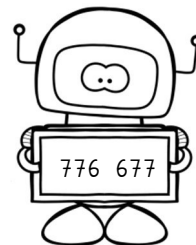

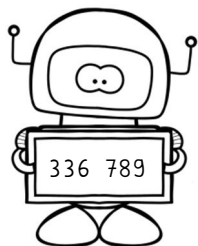

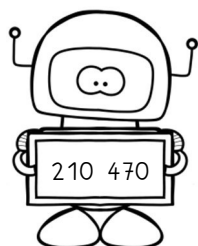

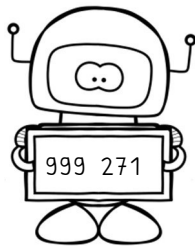

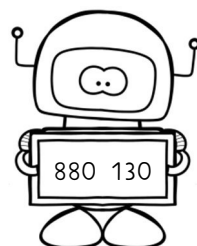

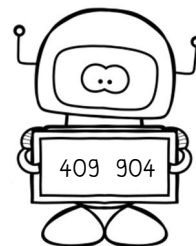

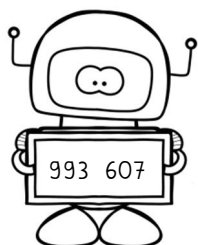

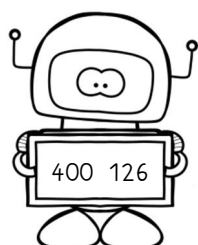

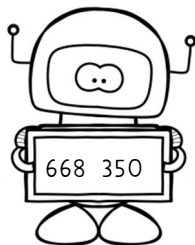

Lösungszahlen:

- 318
- 566
- 210
- 99
- 750
- 495
- 260
- 453
- 274
- 386
- 728
- 488
- 108
- 784

Eine Zahl bleibt übrig!

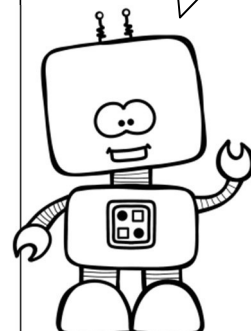

Das kannst du!

Name: _____

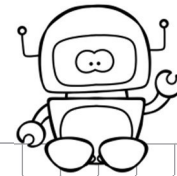

Rechne schriftlich! Kontrolliere!

$$\begin{array}{r} 544 \\ + 332 \\ \hline \end{array}$$

$$\begin{array}{r} 107 \\ + 532 \\ \hline \end{array}$$

$$\begin{array}{r} 347 \\ + 309 \\ \hline \end{array}$$

$$\begin{array}{r} 884 \\ + 33 \\ \hline \end{array}$$

Lösungen:
917
656
639
876
719

$$\begin{array}{r} 454 \\ + 277 \\ \hline \end{array}$$

$$\begin{array}{r} 186 \\ + 357 \\ \hline \end{array}$$

$$\begin{array}{r} 562 \\ + 254 \\ \hline \end{array}$$

$$\begin{array}{r} 76 \\ + 784 \\ \hline \end{array}$$

Lösungen:
816
860
544
543
731

$$\begin{array}{r} 177 \\ - 121 \\ \hline \end{array}$$

$$\begin{array}{r} 543 \\ - 460 \\ \hline \end{array}$$

$$\begin{array}{r} 322 \\ - 187 \\ \hline \end{array}$$

$$\begin{array}{r} 855 \\ - 772 \\ \hline \end{array}$$

Lösungen:
83
56
83
38
135

$$\begin{array}{r} 765 \\ - 407 \\ \hline \end{array}$$

$$\begin{array}{r} 109 \\ - 47 \\ \hline \end{array}$$

$$\begin{array}{r} 567 \\ - 109 \\ \hline \end{array}$$

$$\begin{array}{r} 601 \\ - 578 \\ \hline \end{array}$$

Lösungen:
62
23
458
358
923

$$\begin{array}{r} 467 \\ + 288 \\ \hline \end{array}$$

$$\begin{array}{r} 318 \\ - 274 \\ \hline \end{array}$$

$$\begin{array}{r} 99 \\ + 507 \\ \hline \end{array}$$

$$\begin{array}{r} 848 \\ - 265 \\ \hline \end{array}$$

Lösungen:
755
583
606
144
44

Das kannst du!

Name: _____

Löse die Rechendreiecke! Kontrolliere!

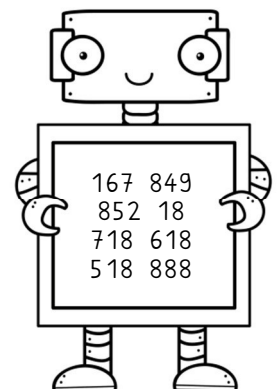
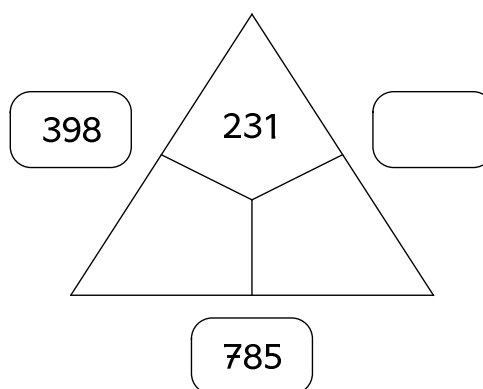
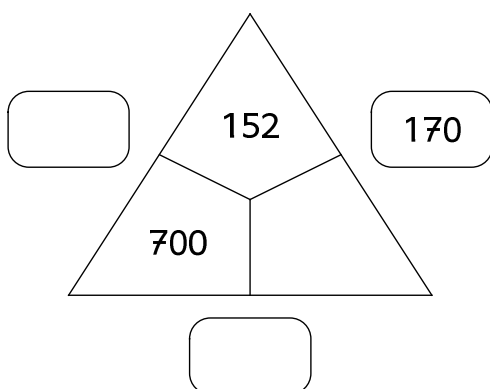
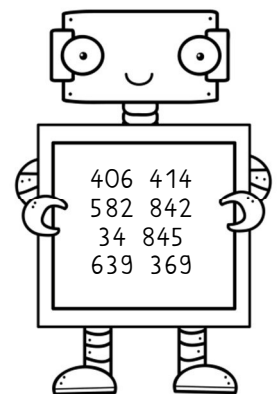
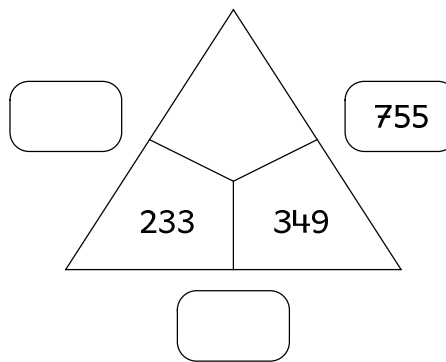
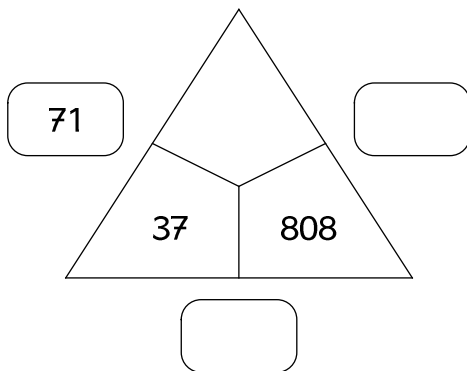
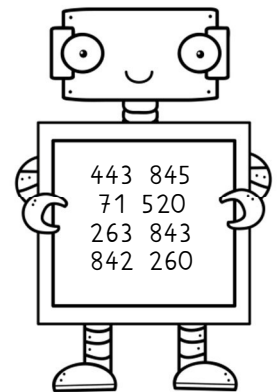
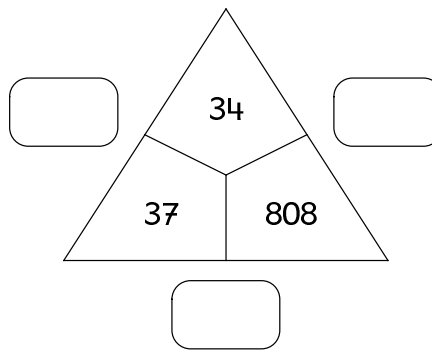
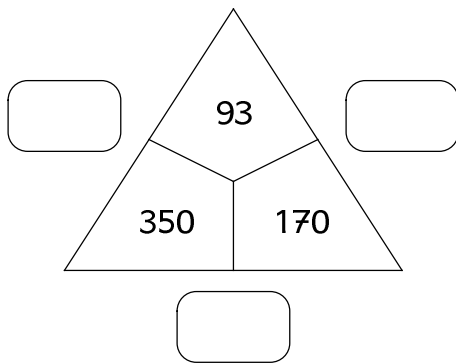
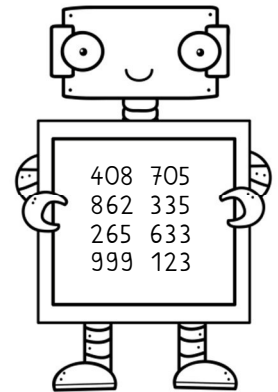
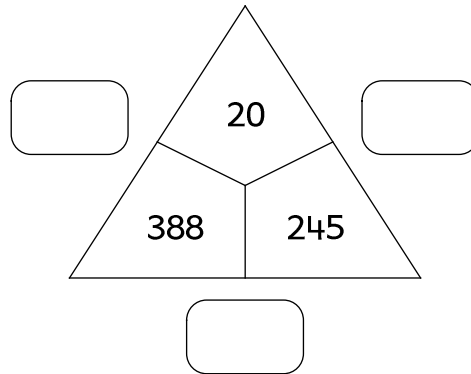
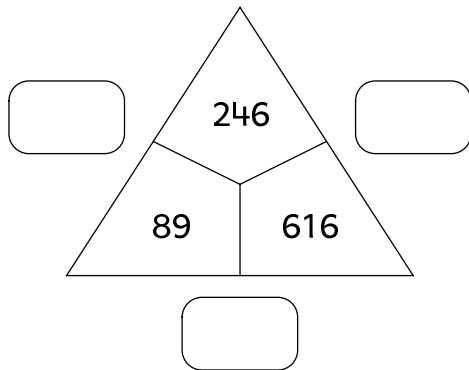

Das kannst du!

Name: _____

Löse die Rechengeschichten. Kontrolliere deine Lösung!

Rolf Roller ist ein Putzroboter.
Heute hat er schon 300min geputzt.
Gestern waren es 189min weniger. Wie viele
Minuten war Rolf Roller gestern beschäftigt?

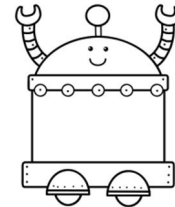
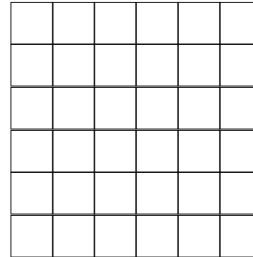

110min

111min

210min

Antwort: _____

Für den Bau von Roboter Willi Winker
wurden 653 Schrauben benötigt. Bei seinem
Freund wurden 119 Schrauben mehr
gebraucht. Wie viele Schrauben wären das?

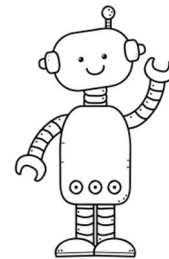
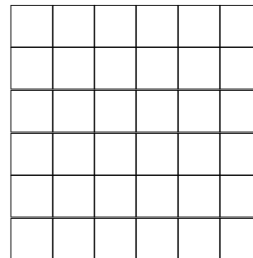

777

771

772

Antwort: _____

Gartenroboter Reinhard kostet 1011€. Wer
ihn innerhalb dieser Woche kauft, bekommt
einen Preisnachlass von 97€. Wie viel würde
Roboter Reinhard dann kosten?

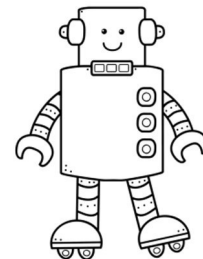
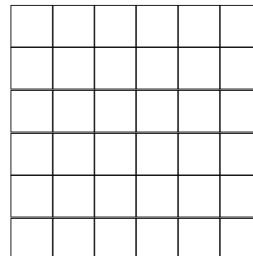

419€

914€

149€

Antwort: _____

Roboter Richard benötigt 70 Sekunden, um
ein Hemd zu bügeln. Wie viele Sekunden
braucht er, um 6 Hemden zu bügeln?
Gib das Ergebnis in Minuten an!

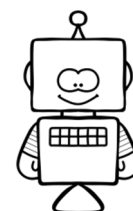
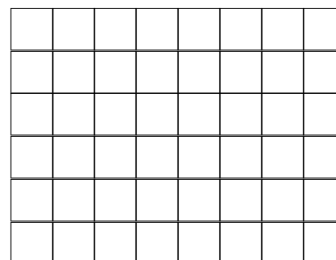

8min

6min

7min

Antwort: _____

Das kannst du!

Name: _____

Ergänze die fehlenden Zahlen im Häuschen! Kontrolliere!

860	
350	
760	
770	
360	
250	
740	

Lösungen:
120
510
100
610
500
90
600

850	
660	
430	
690	
840	
790	
10	

Lösungen:
180
840
420
60
10
190
160

920	
100	
690	
430	
370	
230	
290	

Lösungen:
690
550
820
810
490
230
630

400	
	180
	60
	320
	210
	220
	400

Lösungen:
220
180
190
80
340
10
0

0	
50	
840	
	550
180	810
650	

Lösungen:
340
990
100
940
990
440
150

870	
250	690
	560
	660
	140
	580

Lösungen:
290
620
210
120
310
180
730

Es bleibt immer eine Lösungszahl übrig!



230	
	260
	380
	40
	30
220	
	420

Lösungen:
590
270
490
70
110
450
460

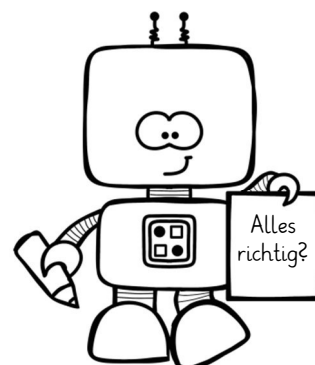

Das kannst du!

Name: _____

Löse die Rechennetze. Kontrolliere deine Außenzahlen!

Immer zwei
Zahlen bleiben
übrig!



Außenzahlen:
160 320 760 900
550 440 430 510

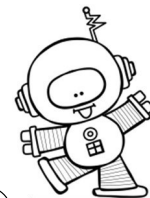
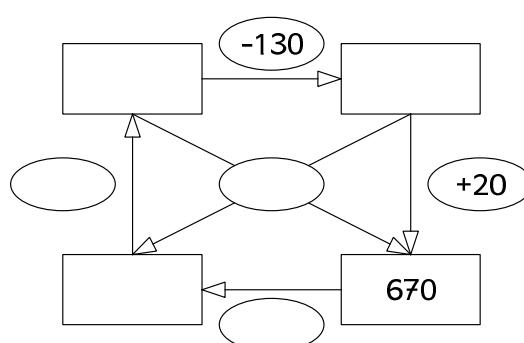
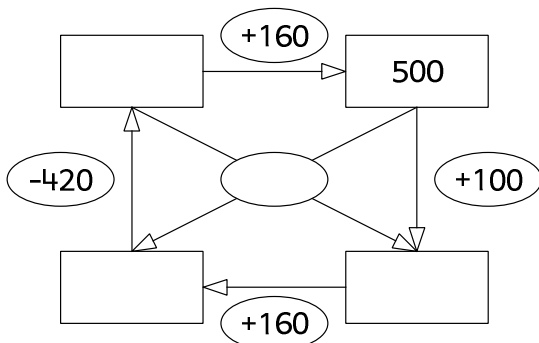
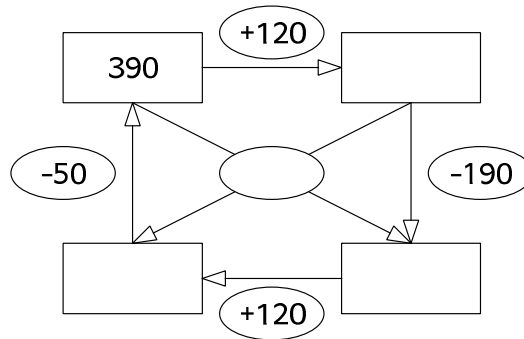
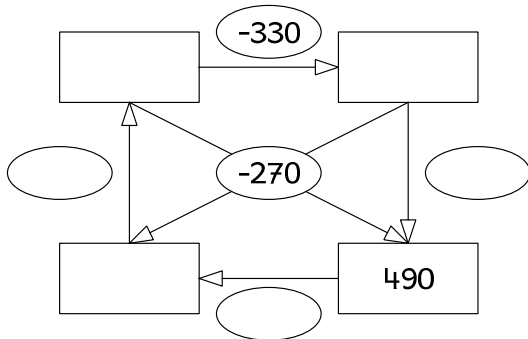

Außenzahlen:
650 660 600 340
780 760 750 540

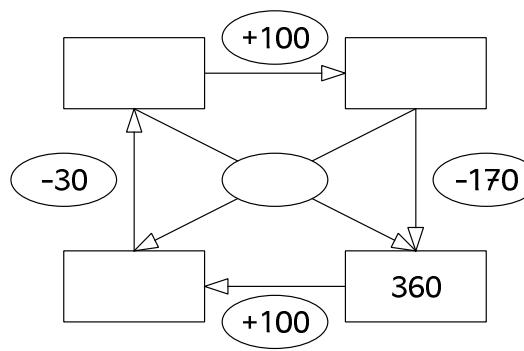
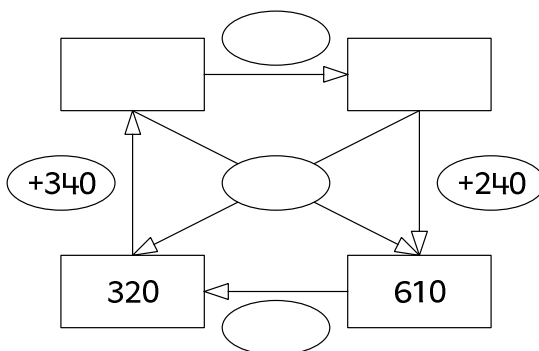

Außenzahlen:
660 530 460 430
370 650 520

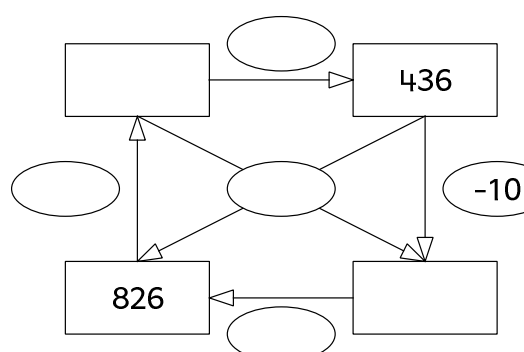
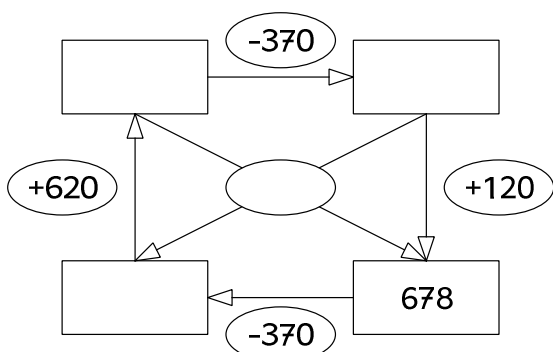

Außenzahlen:
36 558 308 63
426 928 829



Rechenpuzzle: Roboter

Name: _____

<table border="1" style="width: 100%; border-collapse: collapse;"> <tr><td> </td><td>4</td><td>9</td><td>7</td></tr> <tr><td>+</td><td>3</td><td>3</td><td>3</td></tr> <tr><td> </td><td> </td><td> </td><td> </td></tr> <tr><td> </td><td> </td><td> </td><td> </td></tr> </table>		4	9	7	+	3	3	3									<table border="1" style="width: 100%; border-collapse: collapse;"> <tr><td> </td><td>5</td><td>5</td><td>7</td></tr> <tr><td>+</td><td>2</td><td>5</td><td>3</td></tr> <tr><td> </td><td> </td><td> </td><td> </td></tr> <tr><td> </td><td> </td><td> </td><td> </td></tr> </table>		5	5	7	+	2	5	3									<table border="1" style="width: 100%; border-collapse: collapse;"> <tr><td> </td><td>7</td><td>0</td><td>2</td></tr> <tr><td>+</td><td>1</td><td>9</td><td>9</td></tr> <tr><td> </td><td> </td><td> </td><td> </td></tr> <tr><td> </td><td> </td><td> </td><td> </td></tr> </table>		7	0	2	+	1	9	9									<table border="1" style="width: 100%; border-collapse: collapse;"> <tr><td> </td><td>6</td><td>9</td><td>2</td></tr> <tr><td>+</td><td>2</td><td>8</td><td>3</td></tr> <tr><td> </td><td> </td><td> </td><td> </td></tr> <tr><td> </td><td> </td><td> </td><td> </td></tr> </table>		6	9	2	+	2	8	3																								
	4	9	7																																																																																
+	3	3	3																																																																																
	5	5	7																																																																																
+	2	5	3																																																																																
	7	0	2																																																																																
+	1	9	9																																																																																
	6	9	2																																																																																
+	2	8	3																																																																																
<table border="1" style="width: 100%; border-collapse: collapse;"> <tr><td> </td><td>6</td><td>0</td><td>6</td></tr> <tr><td>+</td><td>1</td><td>5</td><td>7</td></tr> <tr><td> </td><td> </td><td> </td><td> </td></tr> <tr><td> </td><td> </td><td> </td><td> </td></tr> </table>		6	0	6	+	1	5	7									<table border="1" style="width: 100%; border-collapse: collapse;"> <tr><td> </td><td>7</td><td>4</td><td>7</td></tr> <tr><td>+</td><td> </td><td>6</td><td>9</td></tr> <tr><td> </td><td> </td><td> </td><td> </td></tr> <tr><td> </td><td> </td><td> </td><td> </td></tr> </table>		7	4	7	+		6	9									<table border="1" style="width: 100%; border-collapse: collapse;"> <tr><td> </td><td>5</td><td>0</td><td>6</td></tr> <tr><td>+</td><td>2</td><td>0</td><td>6</td></tr> <tr><td> </td><td> </td><td> </td><td> </td></tr> <tr><td> </td><td> </td><td> </td><td> </td></tr> </table>		5	0	6	+	2	0	6									<table border="1" style="width: 100%; border-collapse: collapse;"> <tr><td> </td><td>5</td><td>3</td><td>9</td></tr> <tr><td>+</td><td>1</td><td>6</td><td>8</td></tr> <tr><td> </td><td> </td><td> </td><td> </td></tr> <tr><td> </td><td> </td><td> </td><td> </td></tr> </table>		5	3	9	+	1	6	8																								
	6	0	6																																																																																
+	1	5	7																																																																																
	7	4	7																																																																																
+		6	9																																																																																
	5	0	6																																																																																
+	2	0	6																																																																																
	5	3	9																																																																																
+	1	6	8																																																																																
<table border="1" style="width: 100%; border-collapse: collapse;"> <tr><td> </td><td>2</td><td>3</td><td>4</td></tr> <tr><td>+</td><td>1</td><td>9</td><td>7</td></tr> <tr><td>+</td><td> </td><td>5</td><td>6</td></tr> <tr><td> </td><td> </td><td> </td><td> </td></tr> <tr><td> </td><td> </td><td> </td><td> </td></tr> </table>		2	3	4	+	1	9	7	+		5	6									<table border="1" style="width: 100%; border-collapse: collapse;"> <tr><td> </td><td>7</td><td>2</td><td>2</td></tr> <tr><td>+</td><td>1</td><td>8</td><td>8</td></tr> <tr><td>+</td><td> </td><td>8</td><td>1</td></tr> <tr><td> </td><td> </td><td> </td><td> </td></tr> <tr><td> </td><td> </td><td> </td><td> </td></tr> </table>		7	2	2	+	1	8	8	+		8	1									<table border="1" style="width: 100%; border-collapse: collapse;"> <tr><td> </td><td>6</td><td>1</td><td>4</td></tr> <tr><td>+</td><td>1</td><td>0</td><td>6</td></tr> <tr><td>+</td><td>2</td><td>1</td><td>1</td></tr> <tr><td> </td><td> </td><td> </td><td> </td></tr> <tr><td> </td><td> </td><td> </td><td> </td></tr> </table>		6	1	4	+	1	0	6	+	2	1	1									<table border="1" style="width: 100%; border-collapse: collapse;"> <tr><td> </td><td>2</td><td>9</td><td>9</td></tr> <tr><td>+</td><td>1</td><td>8</td><td>8</td></tr> <tr><td>+</td><td>3</td><td>7</td><td>7</td></tr> <tr><td> </td><td> </td><td> </td><td> </td></tr> <tr><td> </td><td> </td><td> </td><td> </td></tr> </table>		2	9	9	+	1	8	8	+	3	7	7								
	2	3	4																																																																																
+	1	9	7																																																																																
+		5	6																																																																																
	7	2	2																																																																																
+	1	8	8																																																																																
+		8	1																																																																																
	6	1	4																																																																																
+	1	0	6																																																																																
+	2	1	1																																																																																
	2	9	9																																																																																
+	1	8	8																																																																																
+	3	7	7																																																																																

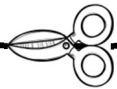
© www.ideenreise.blogspot.de

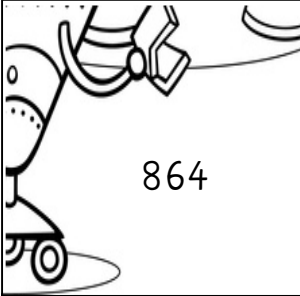
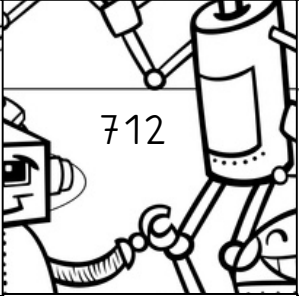
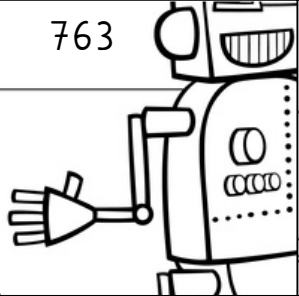
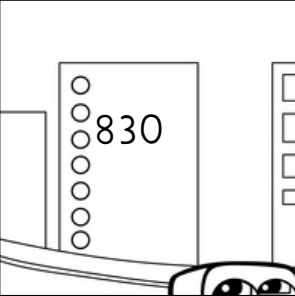
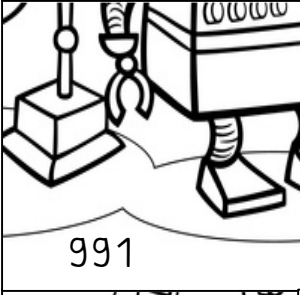
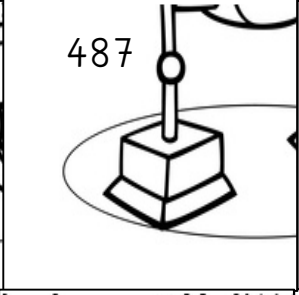
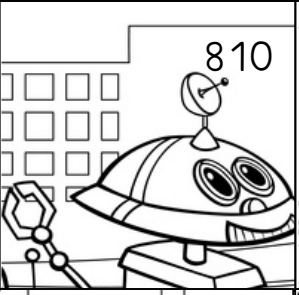
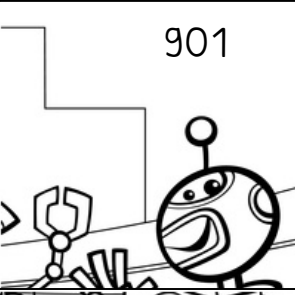

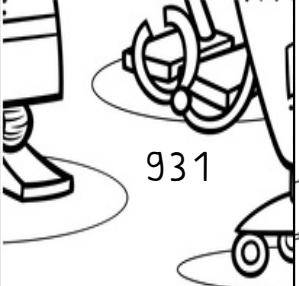
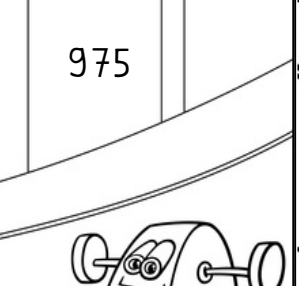
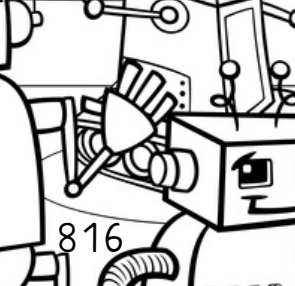
 <p>864</p>	 <p>712</p>	 <p>763</p>	 <p>830</p>
 <p>991</p>	 <p>487</p>	 <p>810</p>	 <p>901</p>
 <p>707</p>	 <p>931</p>	 <p>975</p>	 <p>816</p>

©www.ideenreise.blogspot.de

Schriften: Andika Leseschrift

<http://www.lernsoftware-mathematik.de/?p=1167>

<http://www.will-software.com/index.htm>

KG Second Chances (www.teacherspayteachers.com/Store/Kimberly-Geswein-Fonts)

Illustrationen:

<https://www.teacherspayteachers.com/Store/Teaching-In-The-Tongass>

www.teacherspayteachers.com/Store/Lindy-Du-Plessis

www.teacherspayteachers.com/Store/Educlips

Igor Zakowski (www.fotolia.com)

Aufgaben z. T erstellt mit dem Worksheet Crafter (www.worksheetcrafter.com)